

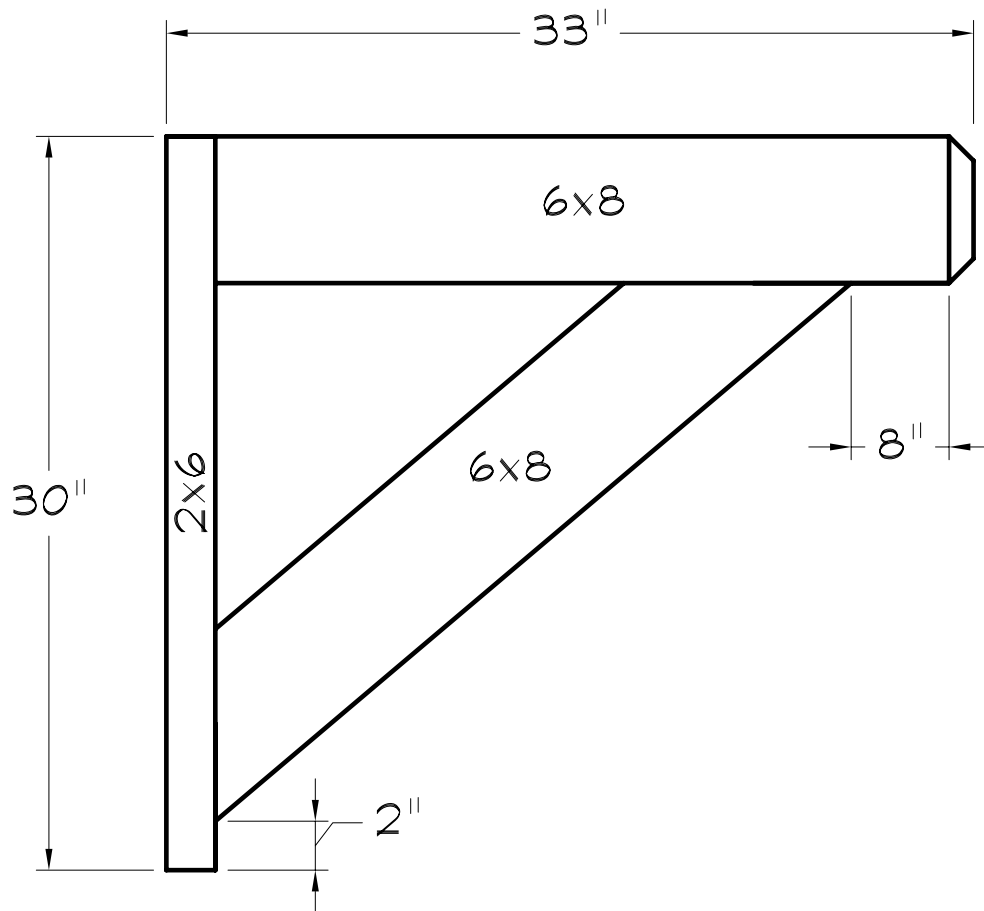

FOAMTEC

11363 Sunrise Gold Cir. , Suite B
Rancho Cordova, CA 95742
office 916.851.8621
email sales@foamtecproduct.com
web www.foamtecproduct.com

RSBRACKET-016
6X8X33
RESAWN BRACKET
CHAMFER END



NOTE:
DRAWINGS NOT TO SCALE