

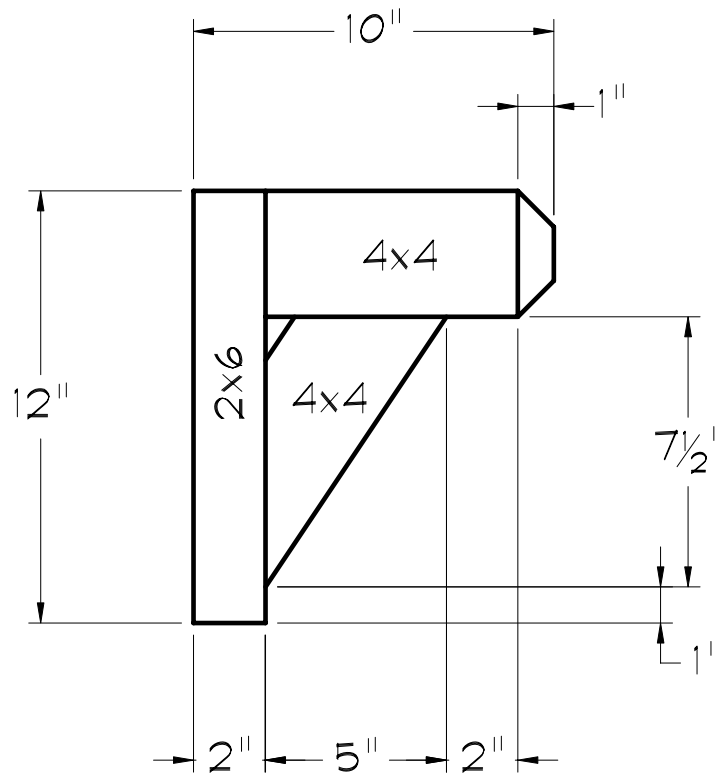

FOAMTEC

11363 Sunrise Gold Cir. , Suite B
Rancho Cordova, CA 95742
office 916.851.8621
email sales@foamtecproduct.com
web www.foamtecproduct.com

RSBRACKET-002 4x4x10 ROUGH SAWN BRACKET CHAMFERED END



NOTE:
DRAWINGS NOT TO SCALE