

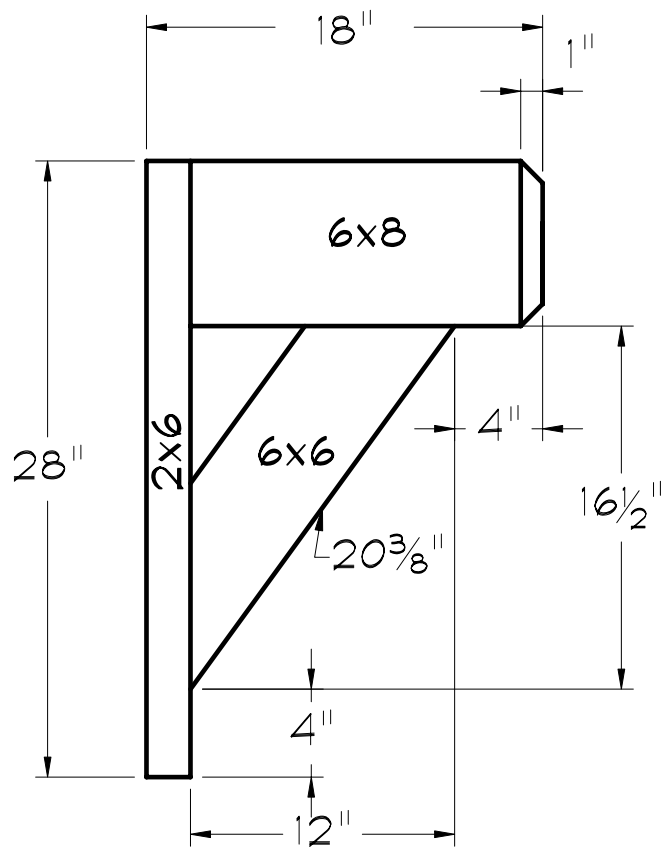

FOAMTEC

11363 Sunrise Gold Cir. , Suite B
Rancho Cordova, CA 95742
office 916.851.8621
email sales@foamtecproduct.com
web www.foamtecproduct.com

RSBRACKET-001
6x8x18
ROUGH SAWN
BRACKET
CHAMFERED END



NOTE:
DRAWINGS NOT TO SCALE