

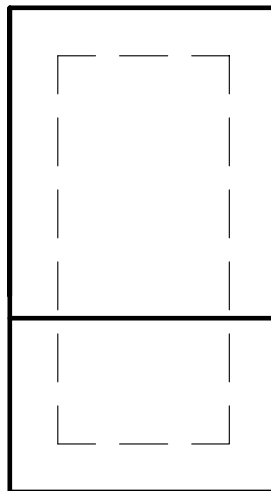

FOAMTEC

11363 Sunrise Gold Cir. , Suite B
Rancho Cordova, CA 95742
office 916.851.8621
email sales@foamtecproduct.com
web www.foamtecproduct.com

RSCOR-018
6x12x12
ROUGH SAWN
CORBEL

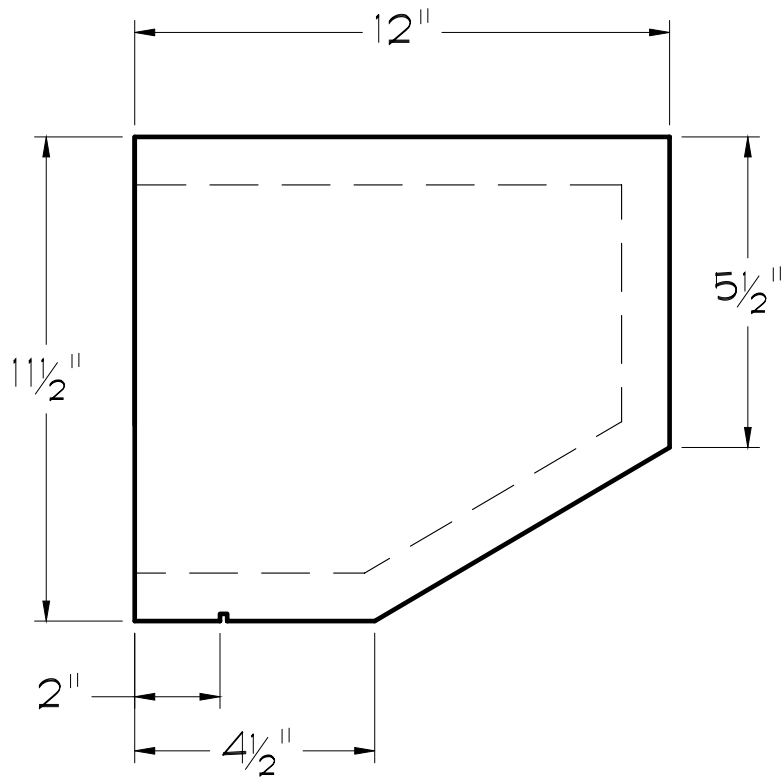

FRONT VIEW

NOTE:
DRAWINGS NOT TO SCALE